

COMEC FC2+2 AUTOMATIC DOUBLE SIDED CHAMFERING / MILLING MACHINE FOR STAIR SPINDLE AND NEWEL POSTS

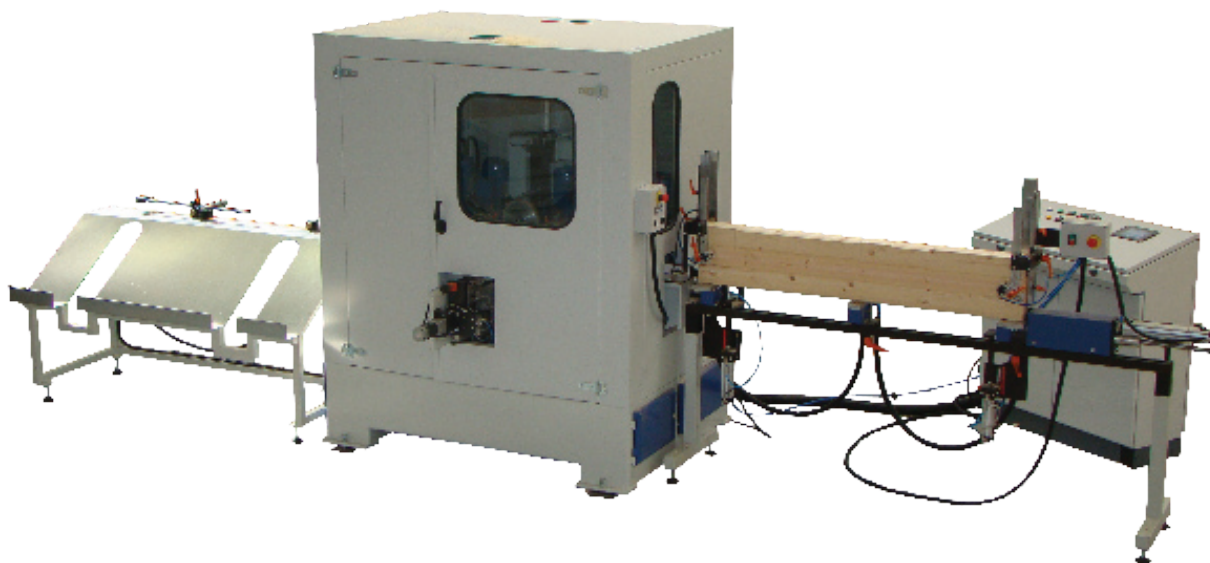

Working Examples:

Stop chamfer spindles. Stop chamfer newels. Stop mould / profiled spindles. Spindle / newel edge / face fluting.

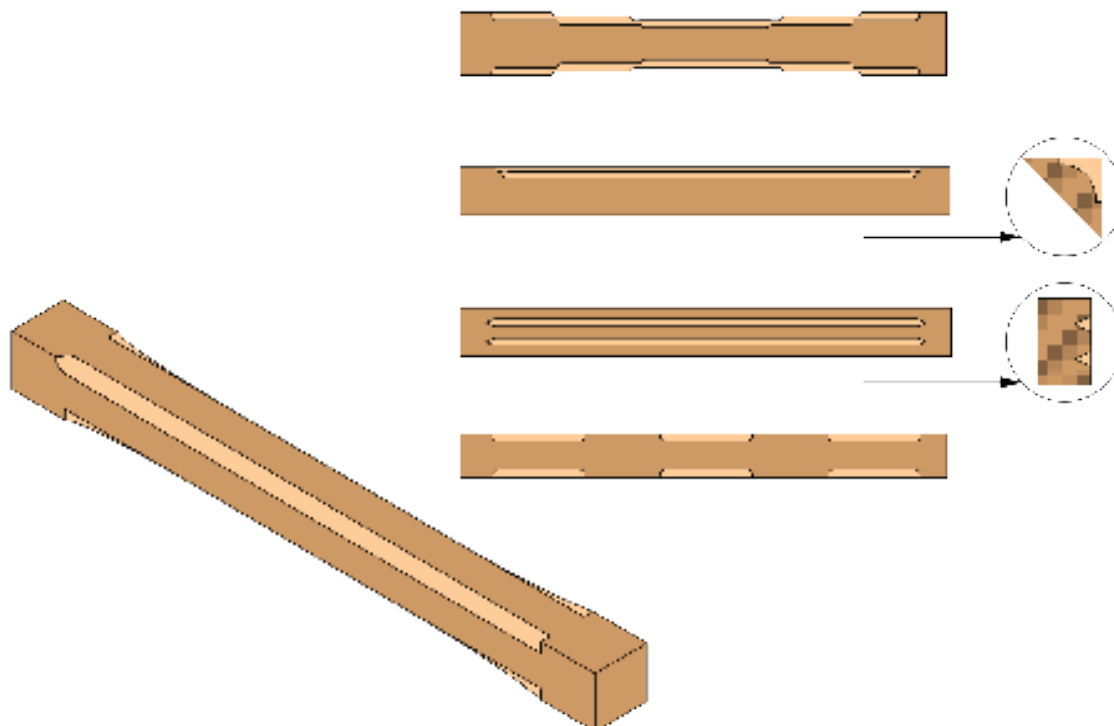

New Comec Model FC2+2 **Automatic Double Sided Chamfering / Milling**

A purpose built heavy duty machine for the volume production, in one pass, of stop chamfered / profiled stair spindles and newel posts. The machine is equipped with an automatic vertical hopper feed loader, through feed roller drive system and 2 +2 milling spindles (1+1 counter rotating to prevent splintering / break out). Operation is totally automatic. Chamfer length, depth, start and stop points are programmed and memorised through touch screen controller. In addition an outfeed table with pneumatic kickers linked to the feeding cycle. Can be supplied on request.

Loading / feeding system

- Automatic vertical hopper feed loading system.
- 6 off top motorised feed rollers system, each with individual motor drive.
- Pneumatic feed roller pressure, regulated.
- Motorised height setting with LED readout.
- Adjustable variable feed speed .
- Idle side pressure rollers with Siko readouts for quick setting.

Milling Group.

- 2 +2 milling groups - 2 left hand / 2 right hand. (1 +1 counter rotating to prevent splintering).
- Each motor 2.25kw.
- Cutter rotation programmable between 5 - 15,000 rpm.
- Cutter spindle dia 35mm
- Cutter max. dia 110mm.
- Cutter / milling head height adjustment through screw and Siko readout.
- Opening / closing of the milling heads through servo motors.

Outfeed System (optional)

- Outfeed inclined take of bench.
- 2 x pneumatic kick of cylinders, second adjustable in position to suit length of component.
- Electronic sensor to activate kicker operation.

Control Board

- Separate electrical control board.
- Omron control with 2x interpolated axis (piece advancement / cutter movement axis).
- 5" touch screen controller - for setting radius, depth of cut, length of cut.
- Possibility to program double depth milling or multiple chamfers.
- Indicative memory capacity 100 programs.

Security

- Sound enclosure with electrically interlocked front / rear doors.
- 3 x dust suction hoods.

Working capacities

- Min. section size with chamfer / profile on all 4 corners - 25mm.
- Max. section size with chamfer / profile on all 4 corners - 90mm.
- Max. length of component in loader - 2000mm (When 90mm sq. approx 1.5m).
- Min. length of chamfer - 280mm approx.
- Max width of chamfer 15/16mm approx (with 110mm dia cutters)
- Min. length of component 700mm approx.



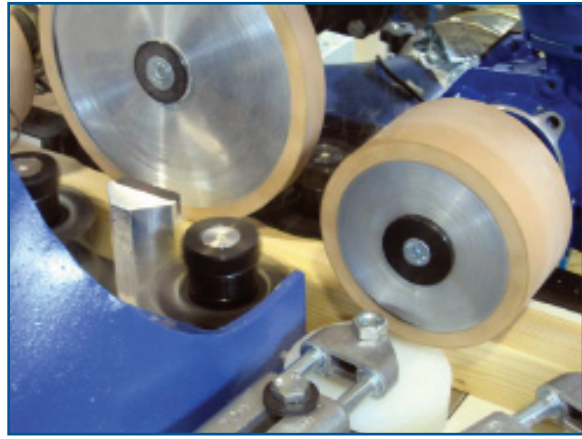
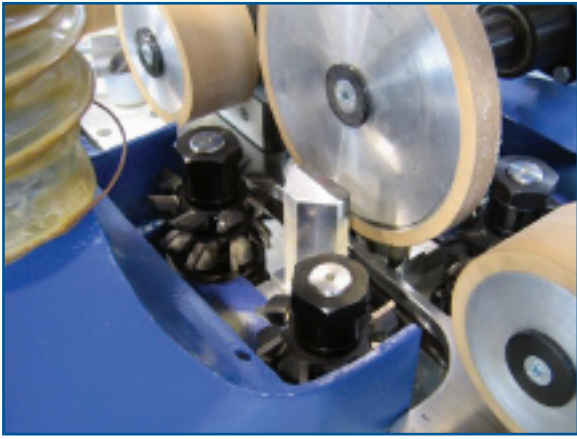

Working Example

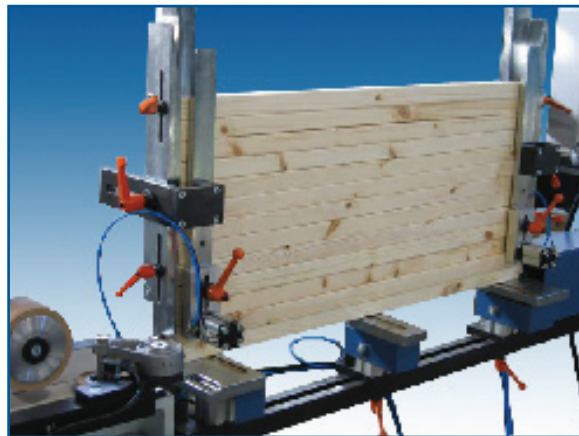
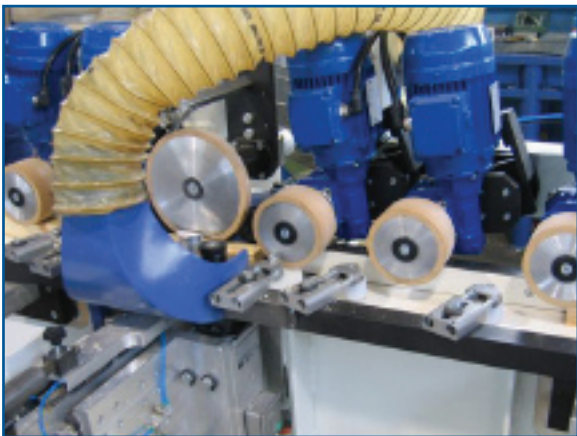
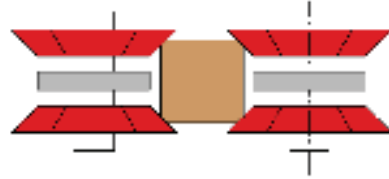
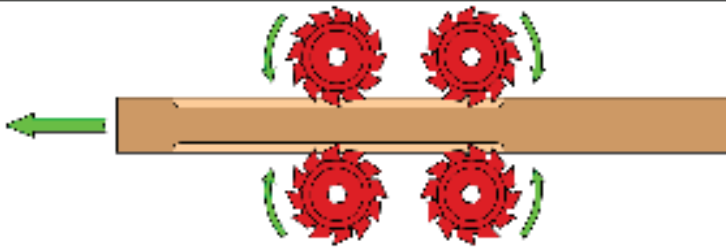

Machine Layout Plan

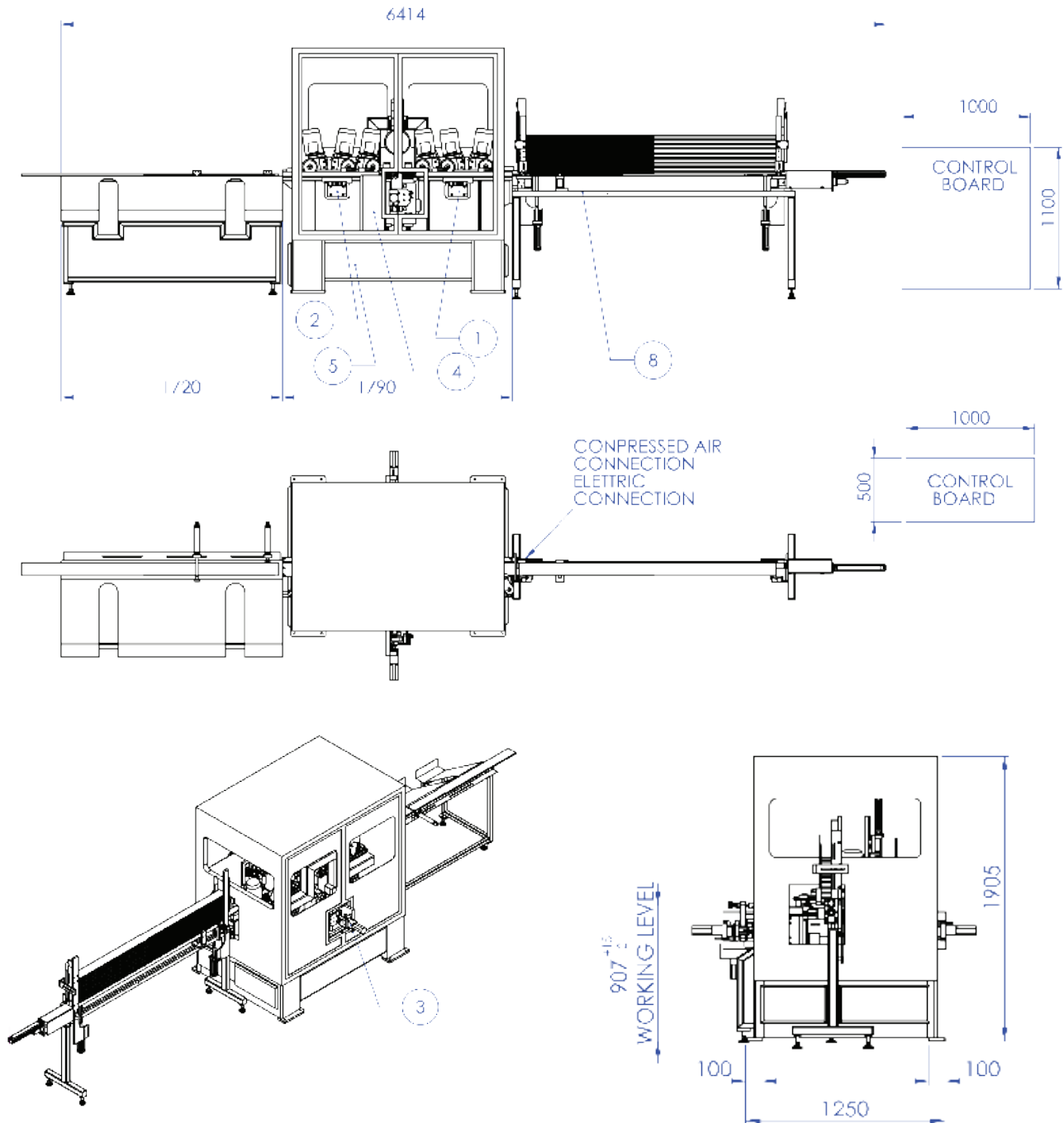

Total installed power 13kw. Air pressure 6 bar. Dust extraction 2 x 100mm diameter. 1x 150mm diameter. Total dust aspiration 3200m³/h.

For further information please contact:

JJ SMITH

Moorgate Road, Knowsley Industrial Park, Kirkby, Liverpool L33 7DR
 tel: 0151 548 9000 - fax: 0151 549 1771 - email: sales@jjsmith.co.uk
 Website: www.jjsmith.co.uk

Machine specification and design subject to change..